



TECHNICAL INFORMATION BULLETIN

NUMBER SIXTEEN

Mechanical Considerations in Pump Design

RADIAL LOADS have to be accurately known and their effects thoroughly understood for good mechanical design . . .

Mechanical failures and excessive maintenance are in most cases a direct result of poor mechanical design, and this is due in a large degree to incomplete knowledge of the radial thrust forces acting on the impeller under actual operating conditions.

It was a principle in the past to determine shaft size only on the basis of horsepower transmitted. This has proven incorrect under the light of present experience. Radial loads generally impose greater demands than horsepower does, and should, therefore, be the predominant factor when determining shaft, bearing and stuffing box sizes and configuration.

Even when the impeller and other rotating parts are carefully balanced, there is always a variation of pressure around the impeller in actual operation. This unequal pressure is caused by reaction forces which develop as a result of volute configuration and the momentum of the fluid leaving the periphery of the impeller. The resultant of these forces pushes the impeller and its shaft away from their normal axis of rotation.

The orientation and value of this resultant is different for different pumps, and even for the same pump under changing conditions of head and capacity. It has taken countless hours of research and experiments to become completely familiar with these forces, which we now simply call "radial loads." Their exact measurement, and the development of this knowledge in general, has contributed greatly towards the elimination of shaft failures and other related problems, such as bearing failures, wear ring seizing, stuffing box leakage, etc. It has reduced very substantially the maintenance and repair bills for pumping equipment in every industry.

Comparative tests of different types and makes of centrifugal pumps have shown that the evaluation of radial loads is a tricky subject, amounting almost to a "character evaluation" for a specific unit under specific conditions. It cannot be generalized to cover every product or even a given series of pumps. It cannot be determined with reliable accuracy by any equation or theoretical formula. It has to be measured physically in the laboratory under simulated working conditions, with methods that cannot be applied in the field.

Peerless has evolved useful design criteria as a direct consequence of countless measurements and radial load studies through the past years. We present here some of the results of this experience because they are definitely an important consideration when purchasing or specifying pumping equipment for the chemical, petroleum and other processing industries. In these applications, requirements of temperature, pressures, nature of fluids pumped and operating conditions in general, impose far greater demands on equipment than does conventional water service.

Through this knowledge, we can now offer better pumps, with the assurance that maintenance problems will be held to a minimum. In addition, however, an awareness of radial loads is also important for the user in the selection of equipment and in the prevention of mechanical failures. Poor hydraulic performance can be detected immediately, but faulty mechanical operation is usually first discovered when a pump fails completely or when irreparable damage has already occurred.

RADIAL LOADS have become the center of mechanical design considerations for volute centrifugal pumps, primarily as a result of experiences obtained in the chemical and petroleum processing industries. The general criteria developed, and the overall awareness of the existence and effects of these loads, have greatly contributed to the

elimination of a whole series of maintenance problems and failures that could not be explained by other normal reasons. The introduction of radial load factors in our design and engineering, besides resulting in a better product, represents also a definite guarantee of longer, uninterrupted, trouble-free service.

Radial loads are schematically shown by small arrows. The resultant force is represented by the large arrow.

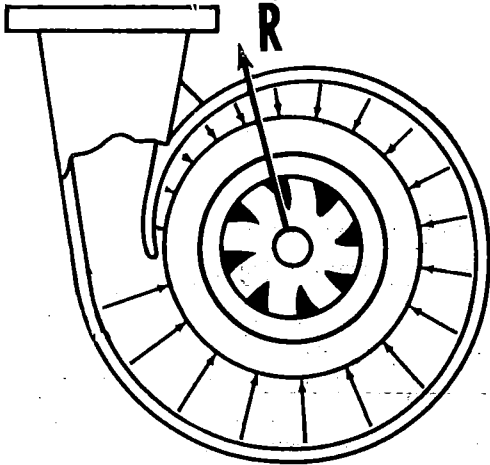

The determination of radial loads begins with the physical measurement of shaft deflection. We actually measure the effect rather than the cause. However, after the effect (shaft deflection) has been determined, the radial load to cause this deflection can be easily calculated.

To measure radial loads we connect the particular pump to a pressure system in our testing laboratory. Water is used for the test, but we can later make the corresponding correction for values obtained, considering the nature and specific gravity of the fluid for which the pump will be used. Two holes are drilled at the suction end of the casing and we place in these holes threaded sleeves through which the tips of special mechanical probes can reach the end of the shaft.

Each probe is directly attached to a micrometer, which provides a direct reading of shaft deflection. To determine the magnitude and direction of the resultant force, we apply the two probes at 90° from each other. Measurements are taken at various head capacity points to obtain a deflection curve through the entire pumping range of the unit.

The shaft on the pump tested is then calibrated statically by hanging weights at the impeller location. A load versus deflection curve is obtained, from which the deflection found under running conditions can be converted to the corresponding force.

After making a number of measurements throughout the capacity curve, we plot the radial load characteristics of that particular pump, obtaining representative curves similar to the ones shown on page 3. The results normally become duplicative for a production series of pumps of the same type and size.

It is possible to relate the radial load F to a series of measurements and physical dimensions of the pump tested. The formula is a purely

$$K = \frac{F(2.31)}{HD_2B_2S}$$

RADIAL LOADS can only be determined by actual measurements and every p

empirical formula widely accepted by industry. K represents the radial load constant. Its numerical value is very useful because it represents the starting point when building a pump similar in design to one already tested. From the above relationships, it is possible to find the constant K for different capacities in the pump being tested. K normally remains a constant only for a given head and capacity condition.

By knowing the constant K across the head and capacity ranges for a given line of pumps, it is possible to use a variation of the above equation to predict the radial loads for a new pump of similar design:

$$F = \frac{KHD_2B_2S}{2.31}$$

Once a prototype of a new pump is available, we measure the actual shaft deflection, and find the actual radial forces involved. If the radial loads remain within our design criteria, the pump is acceptable; if not, a redesign is in order.

There is a basic difference between water and chemical pumps. A water pump is designed to operate at 100% capacity or fairly close to it. In such case, radial forces are not sufficient or do not change enough to present a great problem. But chemical pumps are designed to operate over a wide range of capacities and often run at, or near, shut-off point for extended periods of time. Here is where these forces may appear with destructive effects. By measuring radial forces accurately, and plotting their values over the entire range of operation, we can design and build better pumps at a lower cost.

Different types of casings used in process and transfer pumps show definite trends when the values of F and K are plotted throughout the capacity curve of the pump. The four most important general types are shown on this page with their corresponding typical trends.

RADIAL LOAD

$$F = \frac{K D_2 b_2 H S}{2.31}$$

K = RADIAL LOAD CONSTANT
 D_2 = IMPELLER DIA. (INCHES)
 b_2 = IMPELLER WIDTH (INCHES)
 H = HEAD (FEET)
 S = SPECIFIC GRAVITY

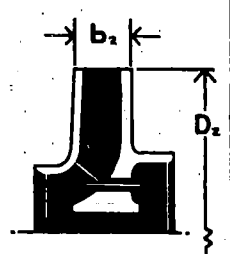

1 Constant Velocity Single Volute. General hydraulic theory is to keep liquid at constant velocity throughout the volute passages. Theoretically, this should result in a constant pressure around the impeller. In practice we find that inequalities of pressure exist and cause radial loads to act on the shaft. Plot of F and K show uniformly descending trend, with peak at shut-off.

2 Double Volute. Also considered a constant velocity design, with the flow divided into two equal streams by two cutwaters 180° apart. Although the volute pressure inequalities remain as in a single volute casing, there are two resultant radial forces opposing each other, owing to its inherent bi-lateral symmetry. Plot of F and K show very uniform trend. Radial forces remain fairly constant through the entire range of heads and capacities.

model should be tested individually

3 Diffusor Volute. Also a constant velocity design, with the flow divided into many equal streams, according to the number of vanes in the diffusor. Again, the volute pressure inequalities remain. Symmetry of diffusor produces many resultant forces opposing each other, but never balancing. Radial loads show less uniformity than double volute type.

4 Constant Area Volute. This type is restricted to small pumps because of poor mechanical and hydraulic characteristics. Non-uniform velocities around the periphery of impeller produce high resultant radial loads. F and K appear different from rest of group, rising steeply as capacity increases and head decreases.

The above trends are useful solely as a guide in the evaluation of different types of pumps. They should not be regarded as a direct and specific index for any individual model since there are many erratic and unpredictable factors involved. Radial load values should be obtained for every particular pump, in the light of actual operating conditions.

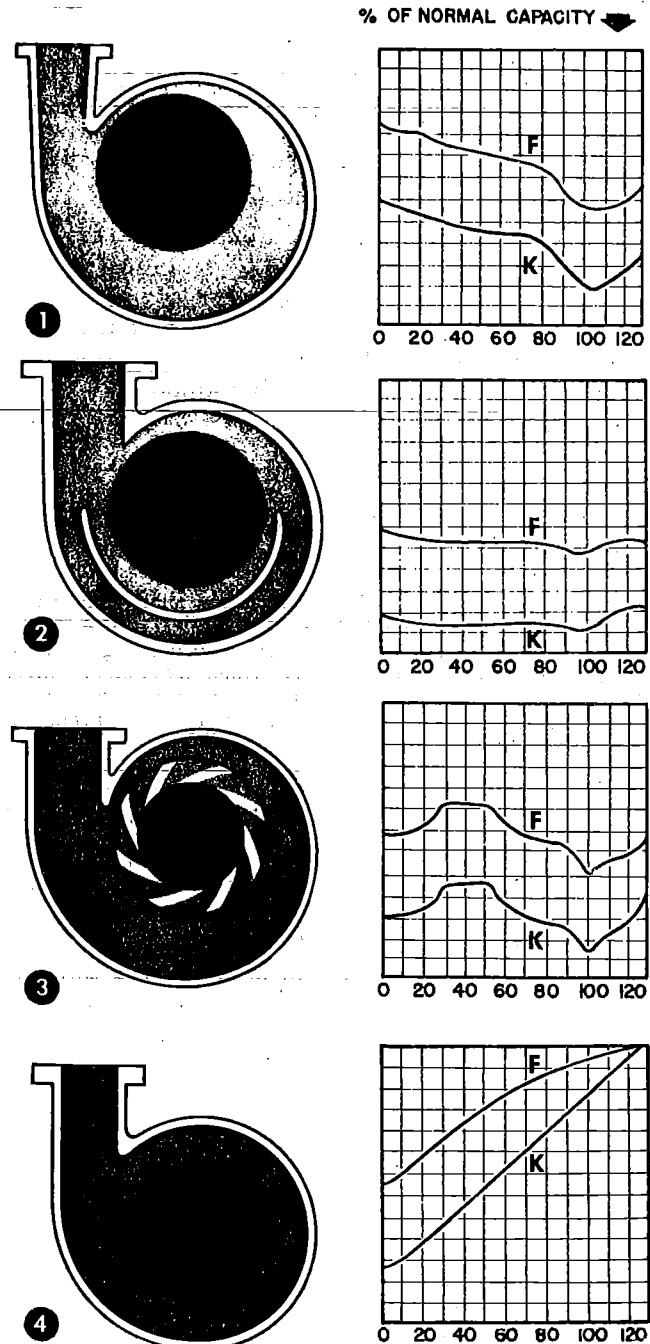

RADIAL LOADS are a major factor when designing the shaft, bearings and other mechanical components

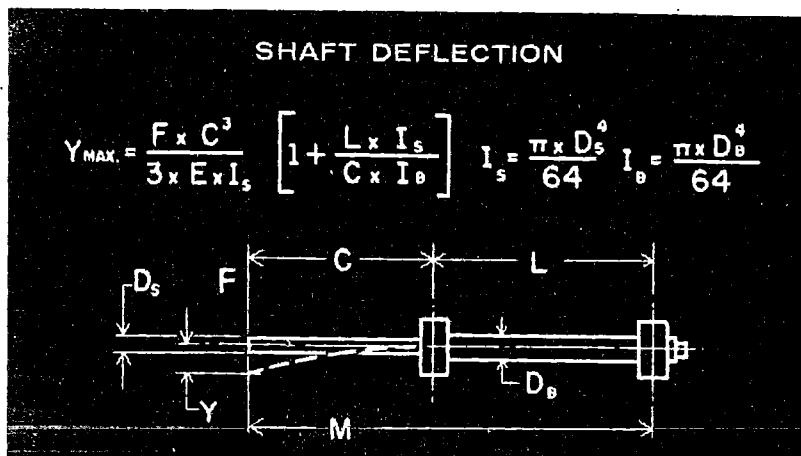

Once we know the radial forces involved, we know all that is needed for proper mechanical design of a pump—a shaft neither too small nor too large, adequate bearings, and optimum size packing or mechanical seal.

Shaft calculation becomes a simple application of a modified beam formula:

$$Y_{MAX} = \frac{FC^3}{3EI_s} \left(1 + \frac{LI_s}{CI_b} \right); I_s = \frac{\pi D_s^4}{64} \text{ and } I_b = \frac{\pi D_b^4}{64}$$

The result, Y_{max} represents the maximum deflection for that particular shaft, when subjected to the measured radial force (F). See accompanying illustration.

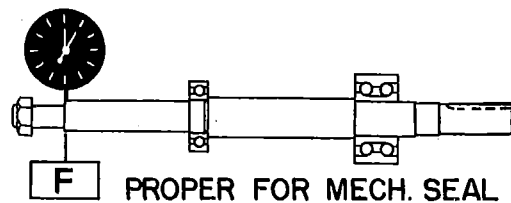
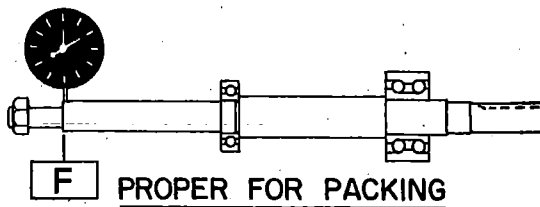
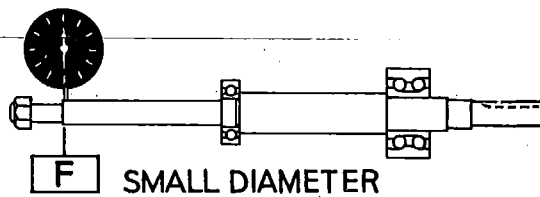
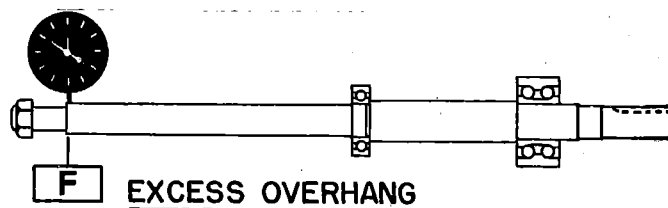

CONCLUSIONS

A shaft has to be sufficiently stiff to absorb without excessive deflection any radial load that might develop in operation. If this is not the case, the shaft will break because of endurance failure or it will produce maintenance troubles at the stuffing box and bearings. Excessive deflection will cause the wear rings to act as bearings, a function for which they are not intended. Excessive rubbing at the wear rings will cause high maintenance and replacement costs.

Even if the shaft does not fail, it is impossible to keep stuffing boxes properly sealed with a bending shaft. The product loss may be substantial or extremely undesirable. The continuous tightening of the gland scores the shaft and induces stress failure or makes it useless in a short period of time. The useful life of bearings is shortened considerably under a shaft with excessive deflection.

If the shaft has been designed in accordance with the actual radial loads that will develop in operation, the pump will wear evenly throughout its useful life, without any component failing prematurely—and maintenance difficulties will be held to a minimum in any type of pumping service.



© 1977 PEERLESS PUMP
10881.5-11.5PP
PRINTED IN U.S.A.

P.O. Box 7026, Indianapolis, Indiana 46206-7026
1441 Peerless Way, Montebello, California 90640

(317) 925-9661 Telex 27-355 FAX (317) 924-7388
(213) 726-1232 Telex 67-4156 FAX (213) 726-0814